

Standard: 2300/3200⁺²⁰/₊₀ mm

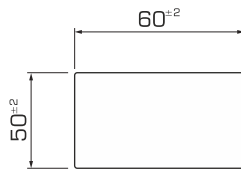

4x40 A2

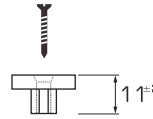

8x100mm



Kit 1m²

8 ml
3,5 ml
32 un.

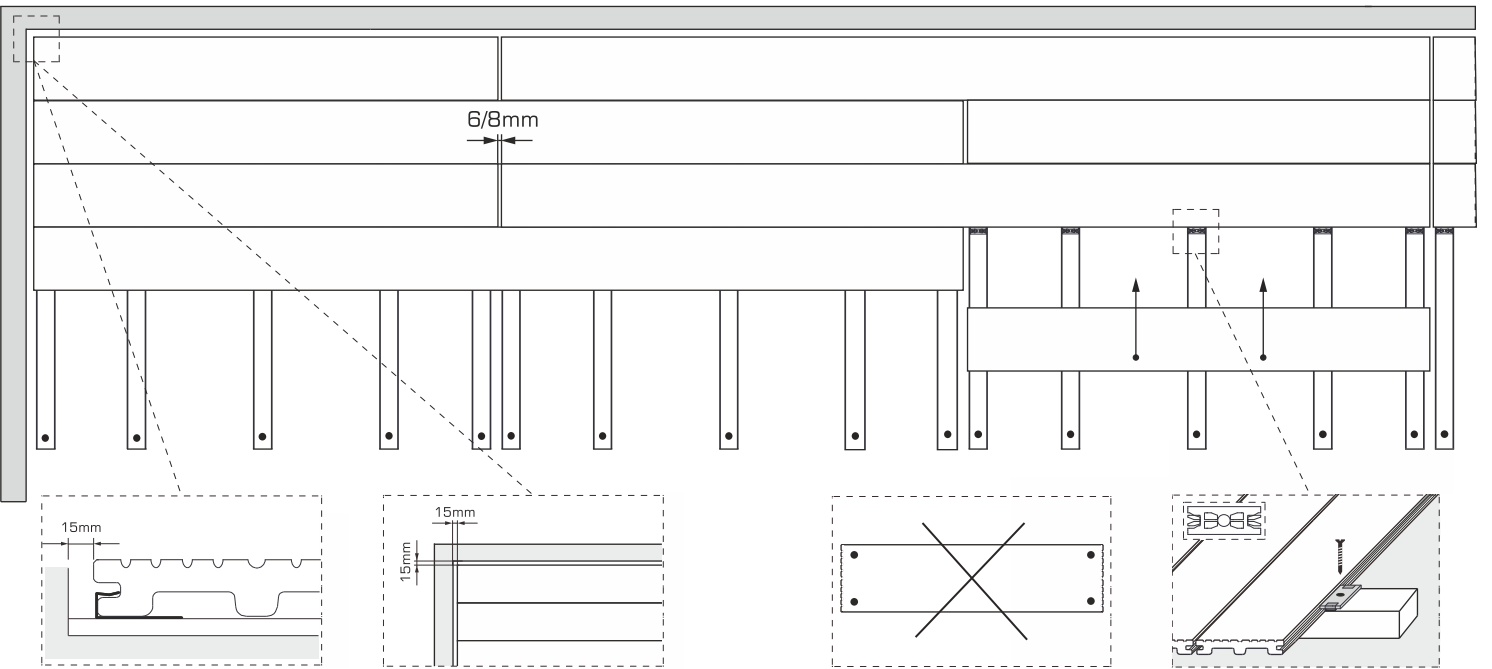
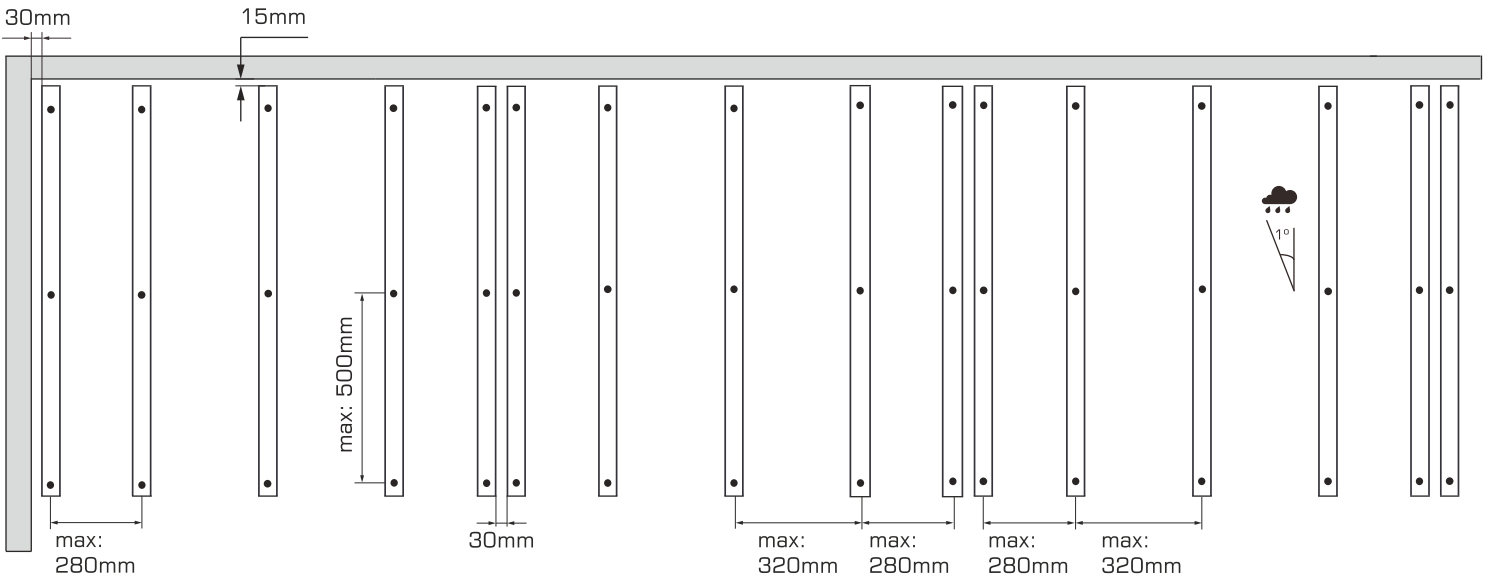
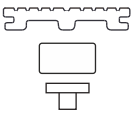

i

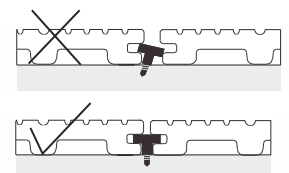
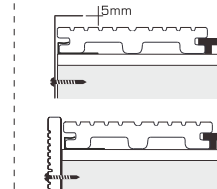
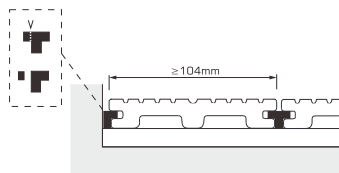
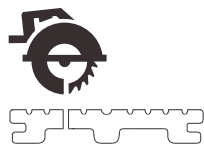
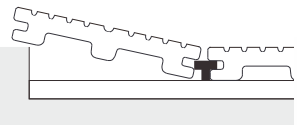

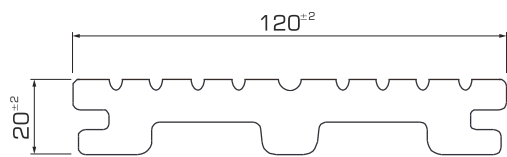
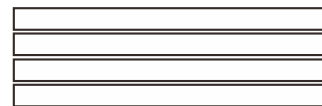

Standard: 2300/3200^{+0/-20} mm

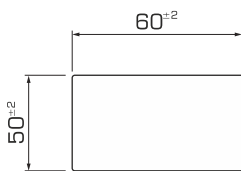

4x40 A2

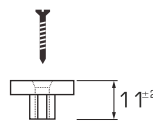

8x100mm



Kit 1m²

8 ml
3,5 ml
32 un.

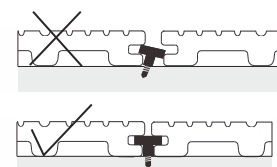
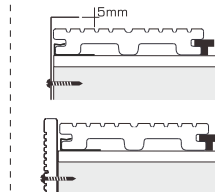
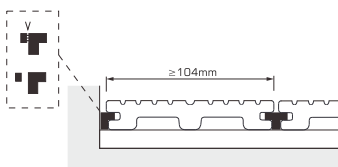
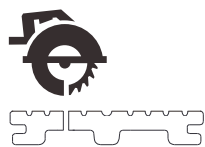
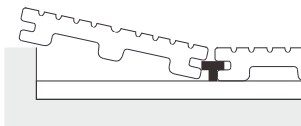
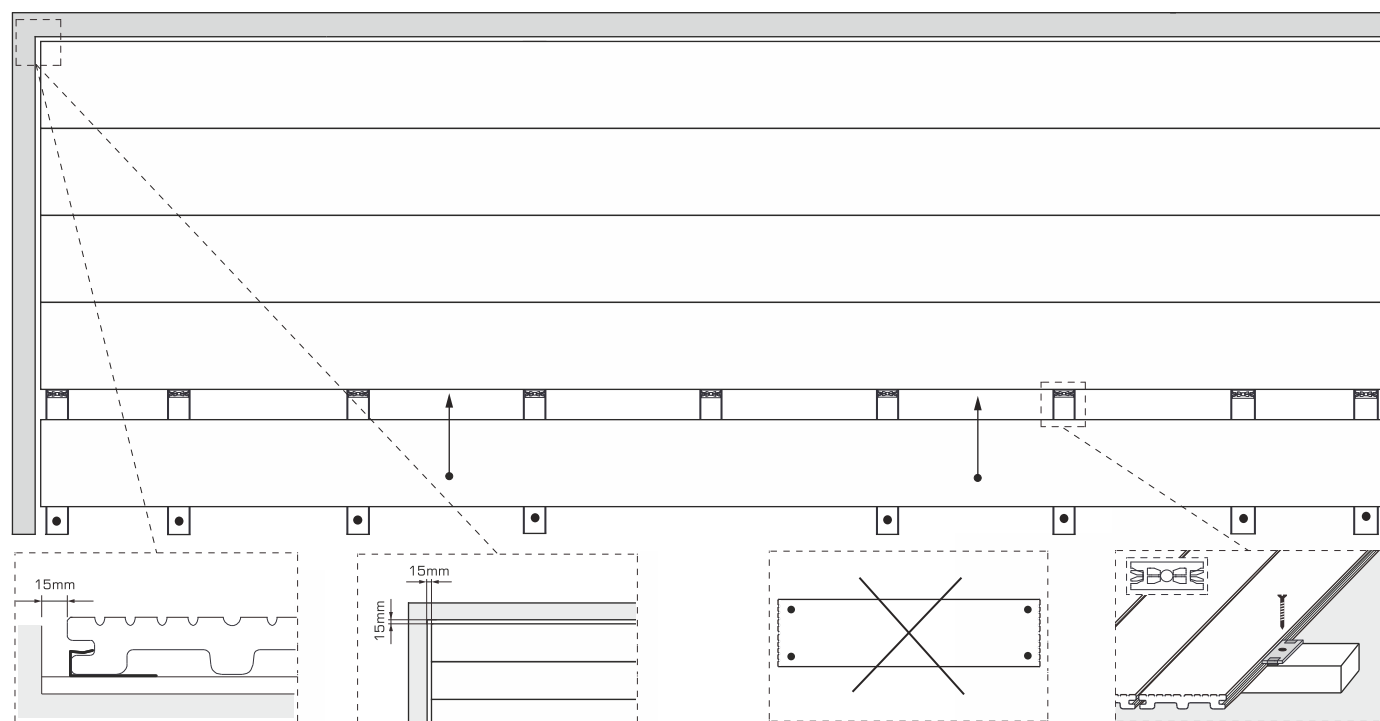
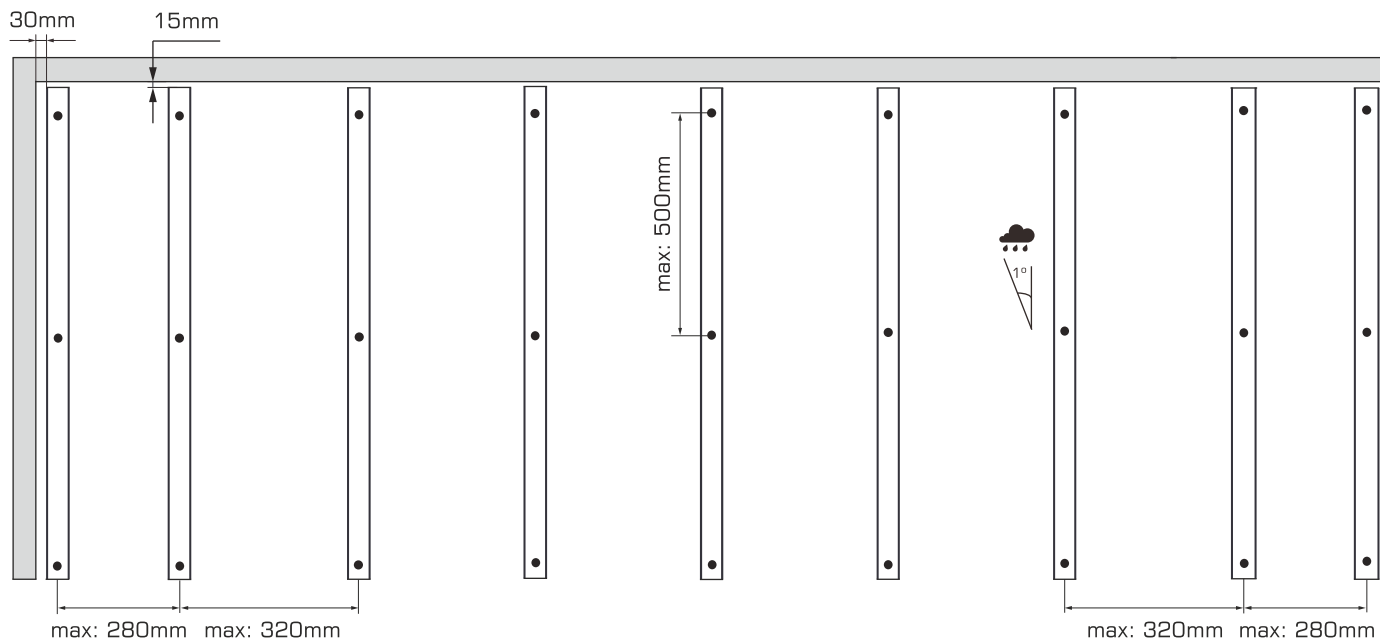
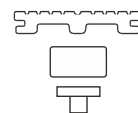

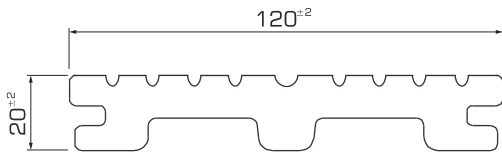

Standard: 2300/3200⁺²⁰₋₀ mm

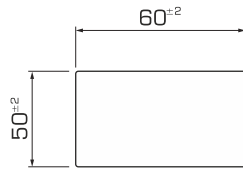

4x40 A2

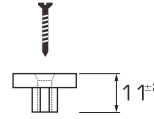

8x100mm

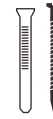

Kit 1m²

8 ml
3,5 ml
32 un.

